

# smart slide full | Power

Drawer Systems

2022.07



**KNAPE & VOGT**

POWERED BY **samet**

## Smart Slide Single and Full Extension Options

---

Smart Slide Drawer Systems meet expectations for advanced design creation with full and single extension options, which are developed with the purpose of meeting various design needs.

### Smooth and Silent Movement

---

Smart Slide Full is engineered to be functional for any drawers. Smart Slide full extension allows you freedom in furniture design such as Day & Night furniture's, bathroom cabinet and also kitchen applications.

Due to special production method with low tolerances, Smart Slide Full operates smooth and effortlessly all the time. Nonstop Synchronization, provided by silicone wheel, ensures smooth and silent running action with lifetime durability.

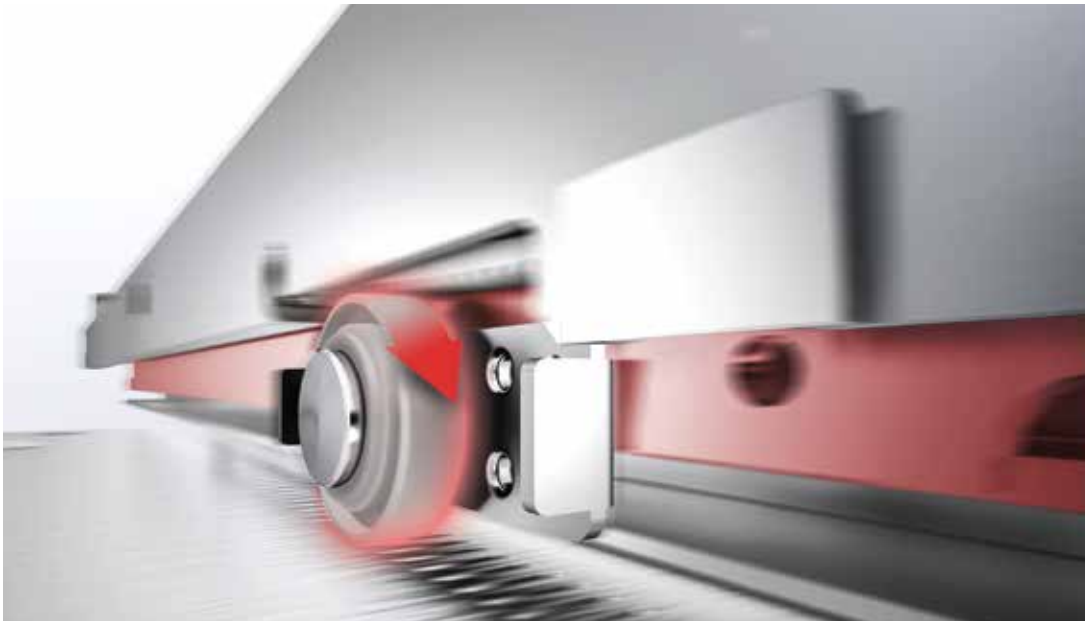

## Lock-Fix Mechanism

---

Lock-Fix mechanism was especially designed for the quick and flexible installation process of Smart Slide Drawer Systems.

With wide drawer size alternatives within a range of 250 mm to 600 mm, different requirements can be met, which ensures different solutions during furniture production. The possibility to lock as tight as desired ensures safety during drawer utilization.



Full Extension Soft Close with Adaptive Damping

## Soft - Close Version

---

The new integrated soft close system ensures gentle and quiet closing.

Thanks to adaptive soft close technology, drawers can be closed softly with same smooth closing effect even if you change the load inside the drawer.



Drawer and Cabinet Dimensions S-C

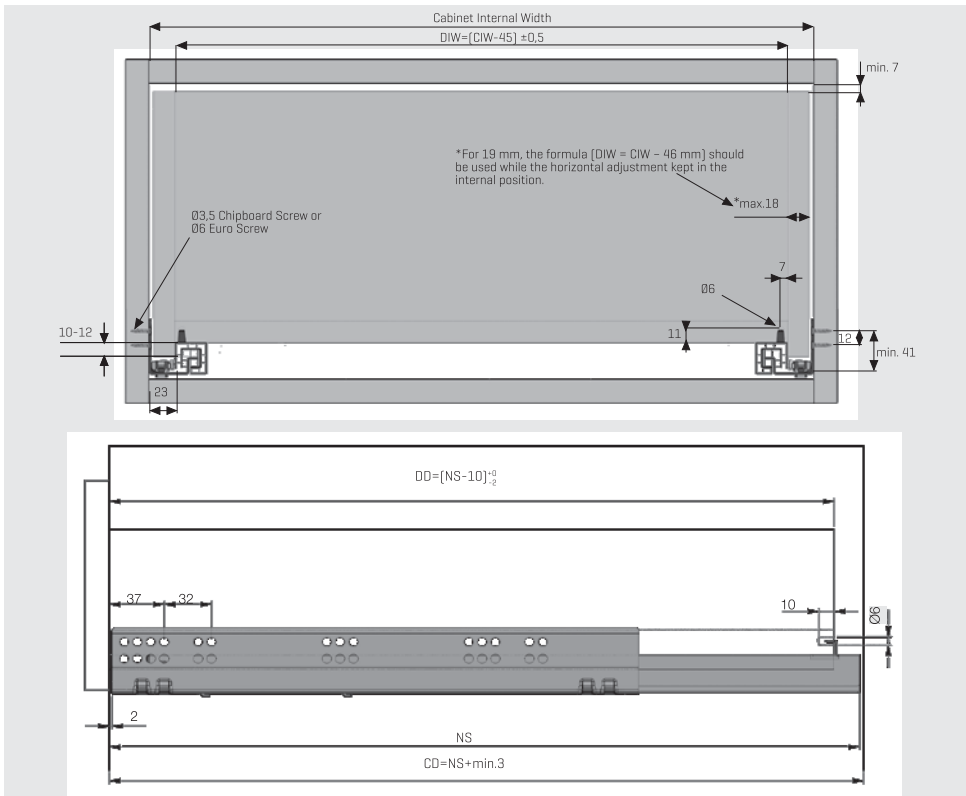

CIW: Cabinet Internal Width

CD: Cabinet Depth

NS: Nominal Size

DIW: Drawer Internal Width

DD: Drawer Depth

Lock - Fix Drilling Holes

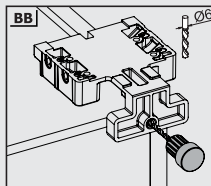
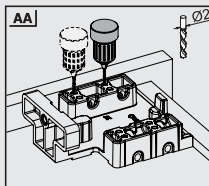
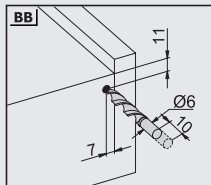
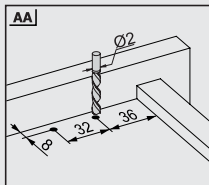
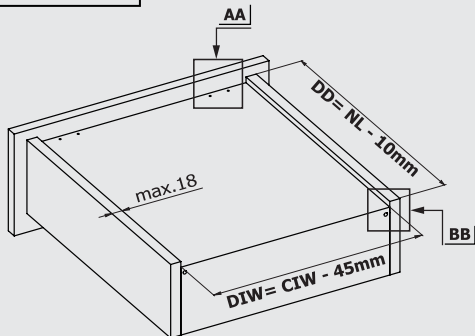

# LOCK - FIX ASSEMBLY INSTRUCTIONS

1

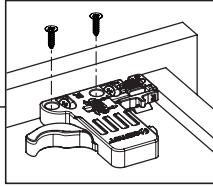
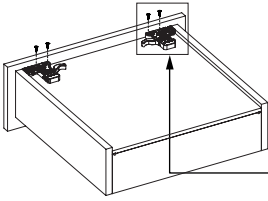

AA

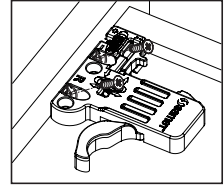
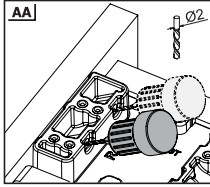

**Note:** Use angled holes to mount smart lock when wooden floor width is selected less than 12 mm.

2

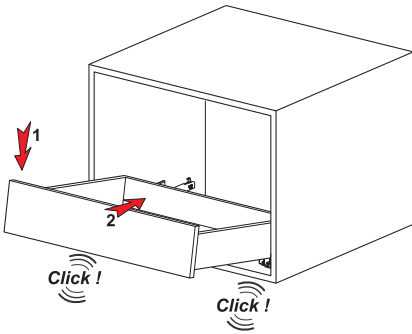

3

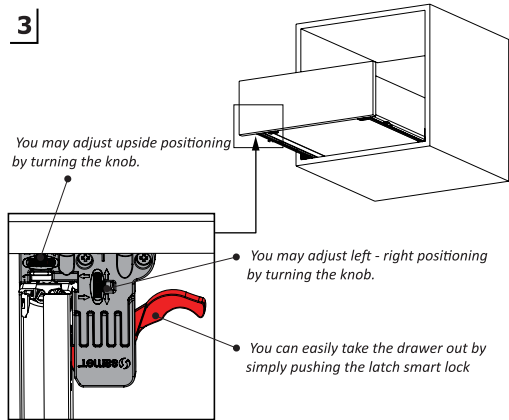

## Screw Location for the Slides

Screw the slide from marked holes.

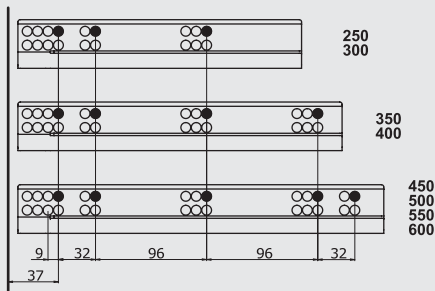

CD Cabinet Depth  
 CIW Cabinet Internal Width  
 NS Nominal Size  
 DIW Drawer Internal Width  
 DD Drawer Depth

## Recommended Screws For Rail Assembly for Assembly

Ø3,5x16 mm Chipboard Screw



Ø6,1x11,5 mm Euro Screw



\* All dimensions in the diagram are in mm

Full Extension Soft Close Lock Fix

Smart Slide Drawer Slide

ITEM	DESCRIPTION	PACKAGE	QUANTITY
KVSUMB 800 10	Smart Slide Full Power Soft Close Undermount Slide 250 mm	Wholesale	6 Set
KVSUMB 801 12	Smart Slide Full Power Soft Close Undermount Slide 300 mm	Wholesale	6 Set
KVSUMB 802 14	Smart Slide Full Power Soft Close Undermount Slide 350 mm	Wholesale	6 Set
KVSUMB 803 16	Smart Slide Full Power Soft Close Undermount Slide 400 mm	Wholesale	6 Set
KVSUMB 804 18	Smart Slide Full Power Soft Close Undermount Slide 450 mm	Wholesale	6 Set
KVSUMB 805 20	Smart Slide Full Power Soft Close Undermount Slide 500 mm	Wholesale	6 Set
KVSUMB 806 22	Smart Slide Full Power Soft Close Undermount Slide 550 mm	Wholesale	6 Set
KVSUMB 807 24	Smart Slide Full Power Soft Close Undermount Slide 600 mm	Wholesale	6 Set

Smart Slide Drawer Slide

ITEM	DESCRIPTION	PACKAGE	QUANTITY
KVSUMB LR 103	Smart Slide Smart Lock 2D Right	Wholesale	120 pcs
KVSUMB LL 104	Smart Slide Smart Lock 2D Left	Wholesale	120 pcs



Smart Slide Accessory

ITEM	DESCRIPTION	PACKAGE	QUANTITY
KVSBBB 107	Drawer Slide Distance Brackets 25 mm Right	Wholesale	50 pcs
KVSBBB 108	Drawer Slide Distance Brackets 25 mm Left	Wholesale	50 pcs



Smart Slide Accessory

ITEM	DESCRIPTION	PACKAGE	QUANTITY
KVSUMB DT 100	Smart Slide Drilling Template	Wholesale	1 pcs

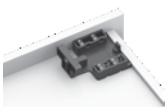

Smart Slide Accessory

CODE	DESCRIPTION	PACKAGE	QUANTITY
KVSUMB DT 101	Smart Slide Smart Lock Drilling Template	Wholesale	10 pcs

Smart Slide Narrow Lock



ITEM	DESCRIPTION	PACKAGE	QUANTITY
KVSUMB LRN 107	Smart Slide Smart Narrow Drawer Lock 2d Right	Wholesale	120 pcs
KVSUMB LRN 108	Smart Slide Smart Narrow Drawer Lock 2d Left	Wholesale	120 pcs

# smart slide full | Power

Drawer Systems



Knape & Vogt reserves the right to change product specifications at any time without notice.

KV and the KV logo are trademarks of Knape & Vogt Manufacturing Company.

©2021 Knape & Vogt Manufacturing Company.



KNAPE & VOGT®

POWERED BY **samet**™



[www.kv.com](http://www.kv.com)



Search Knappe and Vogt on  
your favorite social media sites