

Kabin Ölçüleri
Cabinet Dimensions

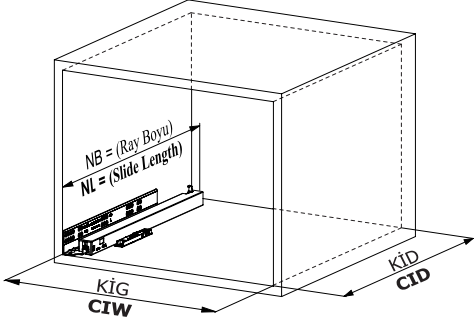

Kabin İç Genişliği	: kIG	Cabinet Internal Width	: CIW
Kabin İç Derinliği	: kID	Cabinet Internal Depth	: CID
Çekmece Derinliği	: ÇD	Drawer Depth	: DD
Çekmece İç Genişliği	: ÇİG	Drawer Internal Width	: DIW
Nominal Boy (Ray boyu): NB		Nominal Length	: NL

Tavsiye Edilen Vida ve Şablonlar
Recommended Screw and Templates

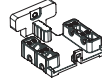

Smart Slide Mandala ve
Tırnak Deligi Delme Şablonu
Smart Lock Template

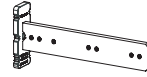

Smart El Tipi Ray
Montaj Şablonu
Smart Drilling Jig

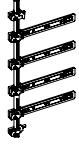

Smart Cetveli Ray
Montaj Şablonu
Smart Drilling Jig with Ruler

Rayların Vida Konum Ölçüleri
Screw Location for the Slides

Rayı, koyu renk ile işaretlenmiş deliklerden vidalayınız.
Screw the slide from marked holes.

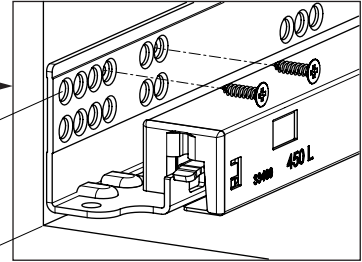
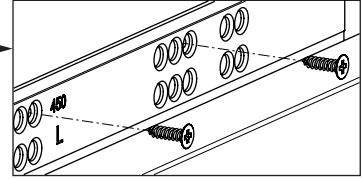
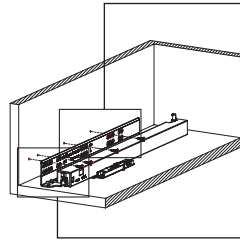
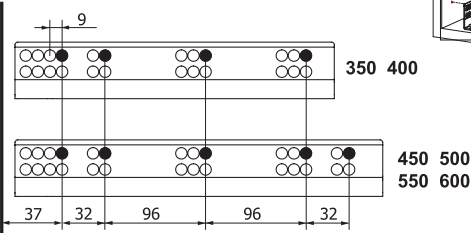

Çekmece Ölçüleri
Drawer Dimensions

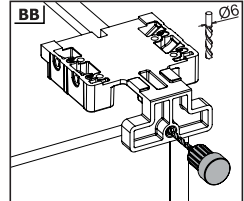
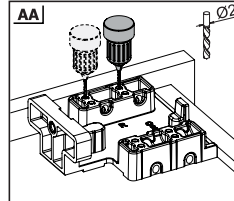
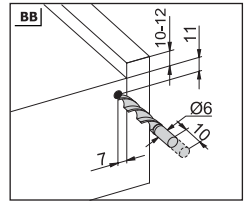
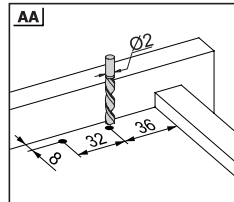
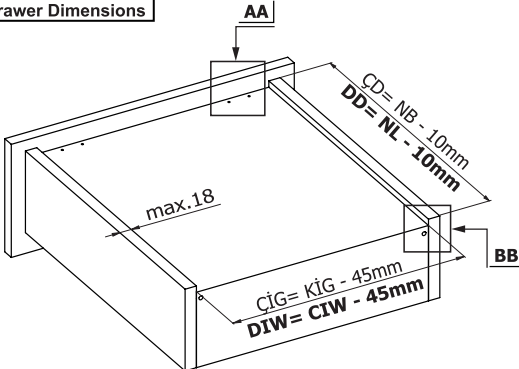

1

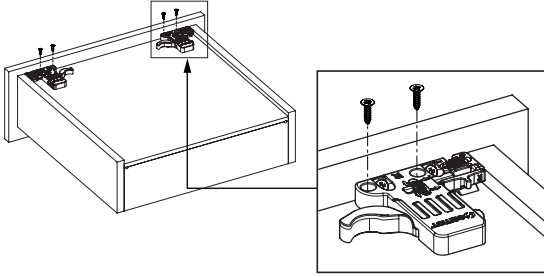

Not: Çekmece taban kalınlığı 12 mm'den küçük olduğunda, açılı mandal bağlama deliklerini kullanınız.

Note: Use angled holes to mount smart lock when wooden floor width is selected less than 12 mm.

AA

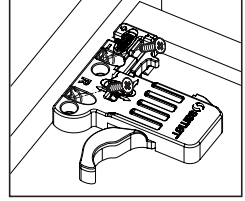
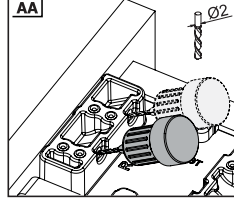

2

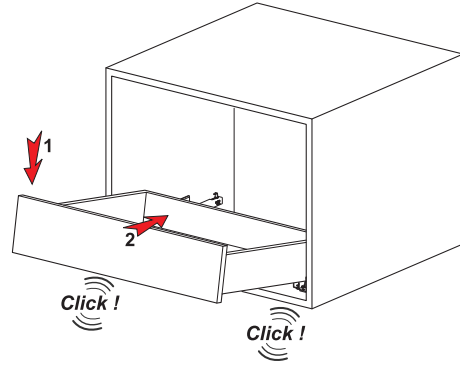

3

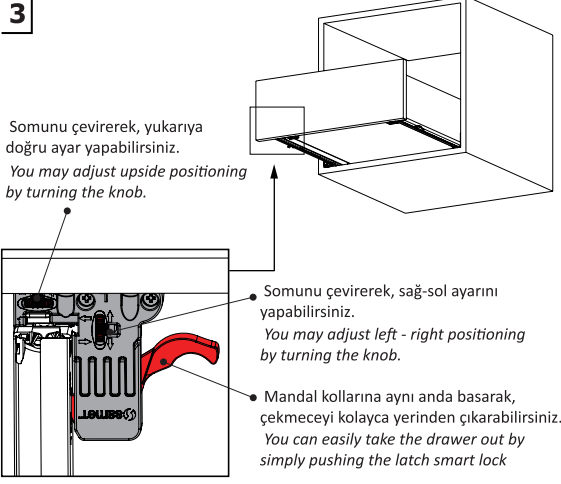

Somunu çevirerek, yukarıya doğru ayar yapabilirsiniz.

You may adjust upside positioning by turning the knob.

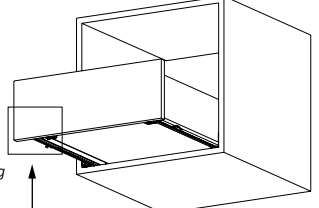

Somunu çevirerek, sağ-sol ayarını yapabilirsiniz.

You may adjust left - right positioning by turning the knob.

Mandal kollarına aynı anda basarak, çekmeceyi kolayca yerinden çıkarabilirsiniz.

You can easily take the drawer out by simply pushing the latch smart lock

Smart El Tipi Ray
Montaj Şablonu
Smart Drilling Jig

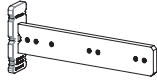

Kod / Code

12799902

12799904

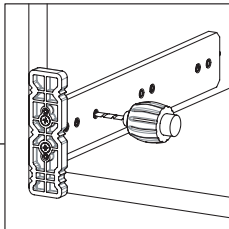
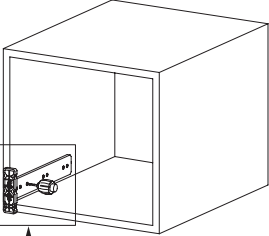

Smart Cetveli Ray
Montaj Şablonu
Smart Drilling Jig with Ruler

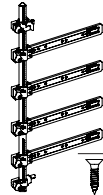

Kod / Code

12799901

12799905

